



pyrite

loomma





inspiration





PYRITE

The fiery stone from the core of the Earth.

This BOMMA collection was inspired by pyrite, the golden fire-stone in the shape of a perfect cube, while the silver version of the shade reflects its inspiration in salt crystals. By blowing a molten organic substance into a precise cold form, the skilled hands of our glassmakers create a unique light fixture of elemental, yet perfect shape. The gleaming surface of this hand-blown crystal cube is enclosed from three sides by a polished metal component in either silver or gold tones.

Design by Dechem Studio



PYRITE

The fiery stone from the core of the Earth.

The Pyrite Collection excels in both exceptional design and top-quality materials. Easily combined, it invites you to create your own unique lighting constellations.

Design by Dechem Studio

production





projects



BOMMA catalogue, 2021



BOMMA Atelier, Prague, 2021



Installation of 98 pcs Salt



Installation of 27 pcs Pyrite



Installation of 36 pcs Pyrite



Installation of 21 pcs Pyrite and Salt

options

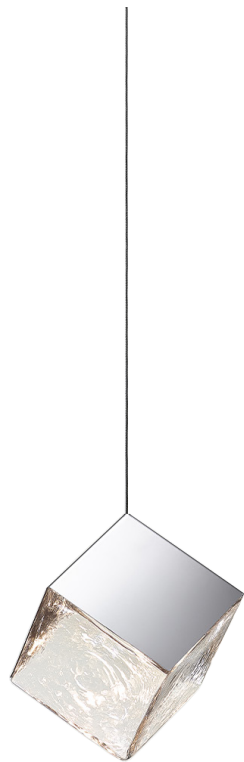

salt
clear glass
silver fitting

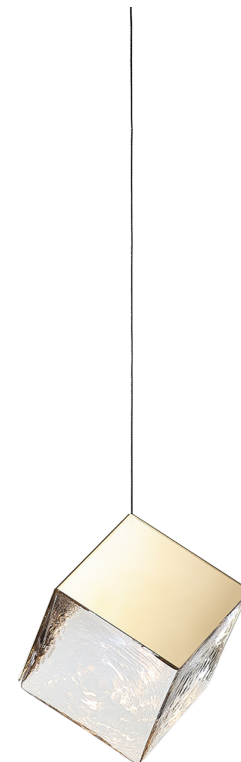

pyrite
clear glass
gold fitting

pendant

Glass options: clear
Fitting options: silver, gold

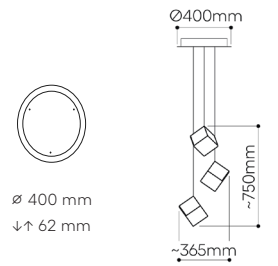

3 pendants

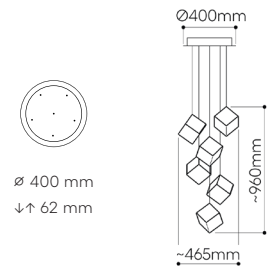

6 pendants

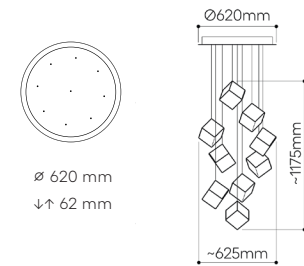

9 pendants

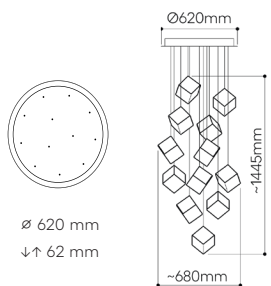

12 pendants

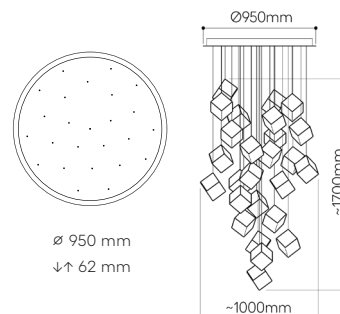

26 pendants

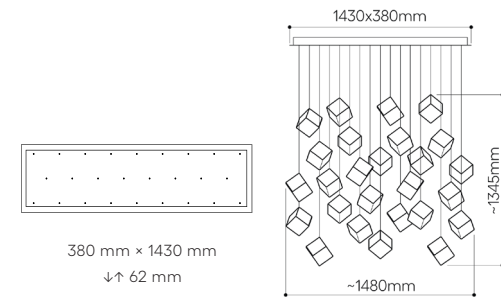

26 pendants
rectangular

chandeliers

Pyrite collection is suitable for bomma constellation. Project your unique vision into space and create your own bomma constellation.

technical informations

Pyrite

Design by
Studio Dechem

All Bomma products are hand-made from mouth-blown lead-free crystal. Therefore any small bubbles, non-melts and irregularities in the glass are both proof and a characteristic feature of this traditional craft.

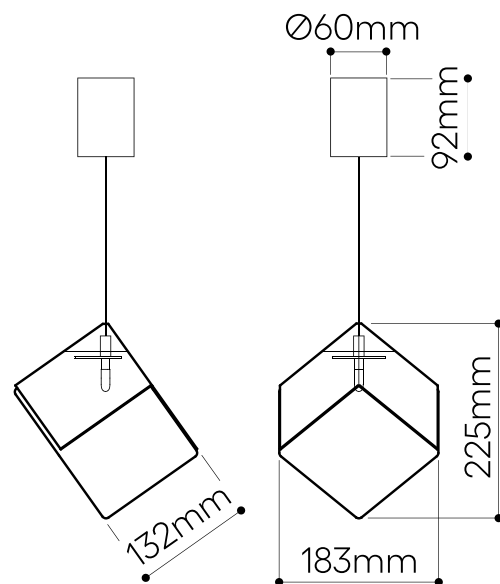

LIGHTING DESCRIPTION

Size	183 × 209 × 225 mm 7,2 × 8,2 × 8,9 inch
Cable	transparent 2,5 m / 98,4 inch
Weigh	1,9 kg / 4,2 lbs
Material	mouth-blown lead-free crystal in clear
Mounting	polished stainless steel / polished stainless steel with nitride titan coating
Mounting Materials	polished stainless steel / polished stainless steel with nitride titan coating
Mounting Colors	silver / gold
Metal sheet top	polished stainless steel, gold
Protection	IP 20
Nominal voltage	220-230V / A.C. 50 hz (EU) 100-120 V / A.C. 60 Hz (USA)
Class	II. EU / I. USA

LIGHT SOURCE

Type	G4, 1,2W LED, 120 lm
Base	G4 (EU) / G4 (USA)
Voltage	12V, AC
Temperature	2700 K
Color index	RA 90+
Dimming	Dimmable with 0/1-10VDC, on demand dimmable with TRIAC.

TRANSFORMER

Primary	100–240V, 50/60 Hz, 0,04A
Secondary	DC 700mA (0,5V–4V) 1×3W

PACKAGING

Material	Cardboard
Size	230 × 220 × 220 mm 9 × 8,6 × 8,6 inch

Origin: traditionally produced in the Czech Republic
Intellectual property license holder: Bomma Czech Republic (EU)
represented by Bohemia Machine s.r.o.

BMRC Group s.r.o.
Hvězdova 1716/2b,
Prague 4, 140 00,
Czech Republic

info@bomma.cz

step beyond